

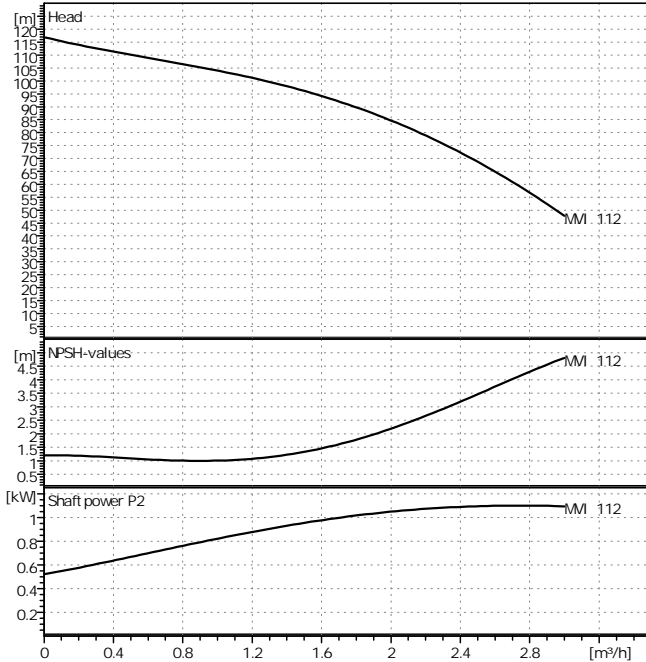

Customer _____ Project _____
 Customer no. _____ Project no. _____
 Contact _____ Position no. _____
 Care of _____ Location _____
 Date 2023-05-06



Requested data

Flow	0	m ³ /h
Head	0	m
Fluid	Water, pure	
Fluid temperature	20	°C
Density	0.9983	kg/dm ³
Kinematic viscosity	1.005	mm ² /s
Vapor pressure	0.02337	bar

Pump data

Make	WILO
Type	MVI 112/ PN16 3~
Pumpe type	Single head pump
Pressure rating	PN 16
Min. fluid temperature	-15 °C
Max. fluid temperature	120 °C

Hydraulic data (duty point)

Flow		m ³ /h
Head		m
Speed	2900	1/min
Shaft power P2		kW
NPSH		m

Materials / Shaft seal

Impellers	1.4301
Stage chambers	1.4301
Pressure casing	1.4301
Shaft	1.4301
Housing cover	1.4301
Seal	EPDM
Mechanical seal	Wolfram carbide/graphit

Dimensions per pump

E	204							
H	718							
h ₂	475							
M	170							
X	127							

Suction side	1" / PN 16
Discharge side	1" / PN 16
Weight	29.2 kg

Motordata per Motor/Pump/

Rated power P2	1.1	kW
Nominal speed	2950	1/min
Rated voltage	3~400 V, 50 Hz	
Max. current	2.4	A
Degree of protection	IP 55	
Permitted voltage tolerance	+/- 10%	

Item no. of standard version 4070477

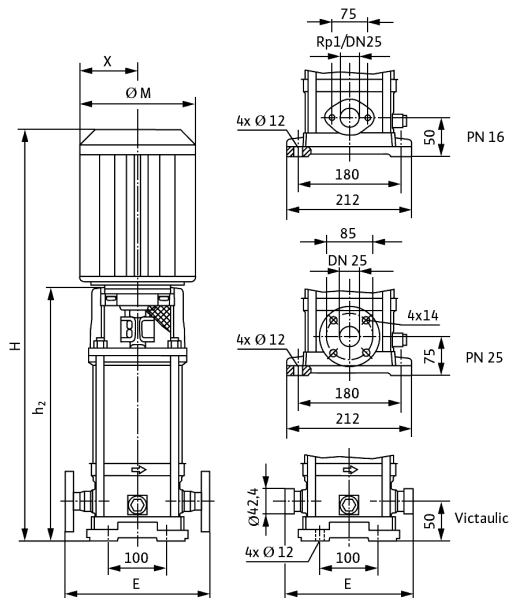

MOT. 230 - 400V (220 - 380V / 240 - 415V)
 < 4kW

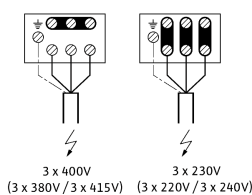

MOT. 400VD (380VD / 415VD)
 > 4kW

